

Scaffold Shipping Rack

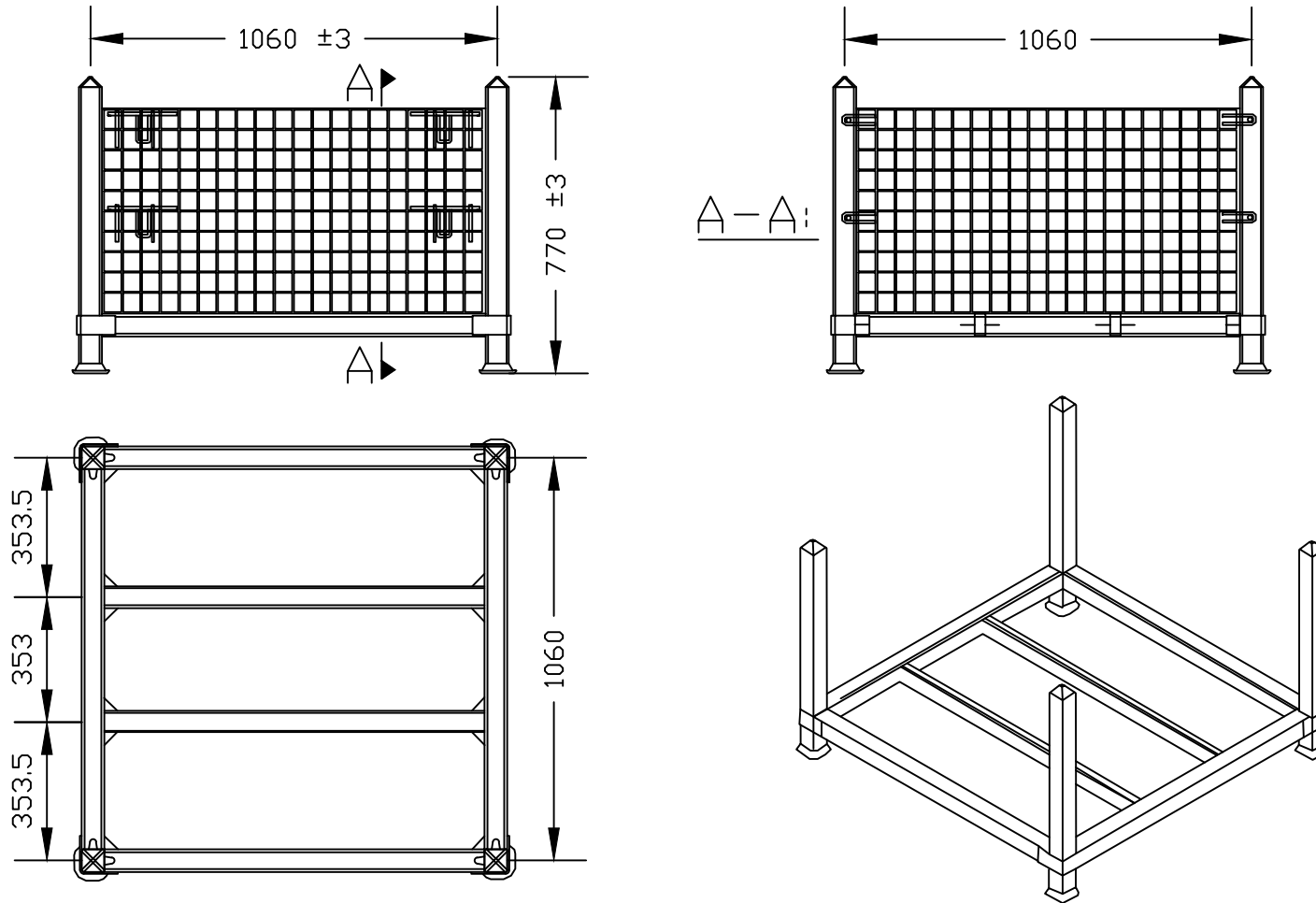

SCAFFOLD SHIPPING RACK

NOTES:

1. THE LAST LETTER IN THE ITEM NUMBER DETERMINES THE COATING, P=POWDER COATED (PWC) AND G=GALVANIZED COATED (HDG)
2. ALT. UNITS ARE MILLIMETERS

ITEM	ITEM NO.	Size	WEIGHT (kg)	WEIGHT (lbs)
CAGE INSERT	01INSERTG	3.5'x3.5' [1060x1060]	29.0	63.8
SHIPPING RACK	01SSR000E		48.0	105.6
SHIPPING RACK W/ CAGE	01RRC000E		77.0	169.4